

Front View

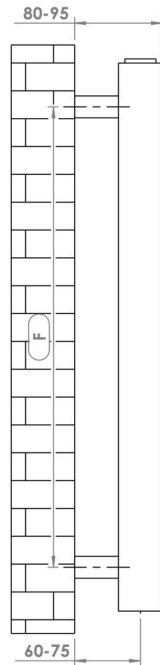

Side View

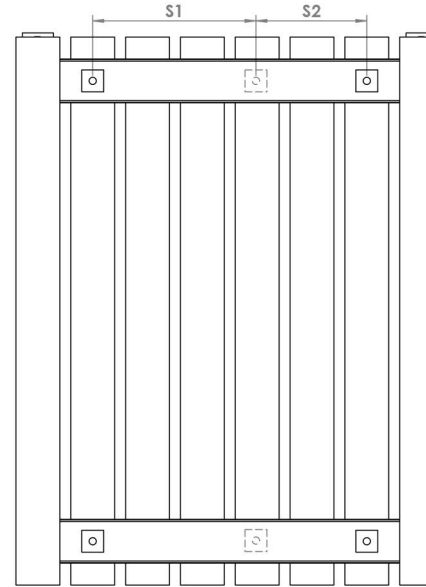

Back View

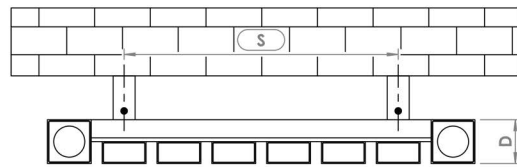
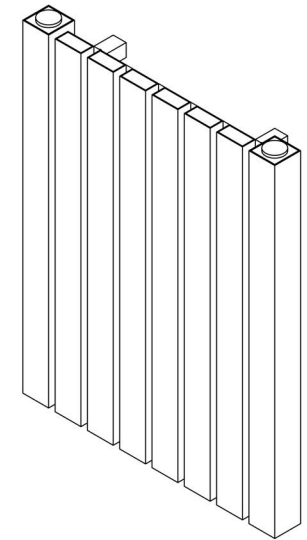

Top View



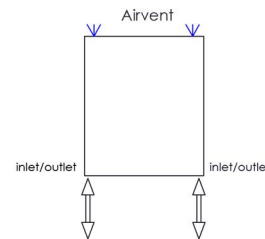



**Plumbing Position:**



Vertical mount  
 All Dimensions are in mm  
 Max. Working Pressure: 10 Bar  
 Max. Working Temperature: 95° C  
 Inlet / Outlet : 1/2" BSP  
 Fuel : E/H/D  
 Manufacturing Tolerance : - 5 mm

Note: Dimension (S1,S2) available for minimum 28 profiles

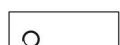
**Installation Accessories:**

-  x4     x4
-  x4     x4
-  x4     x1

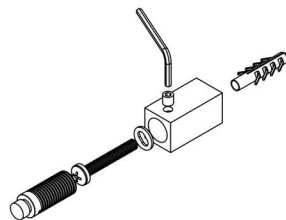

PRODUCT CODE	Height	Length	Depth	Pipe Centres	Bracket Centres	
	H mm	L mm	D mm	C mm	F mm	S (S1-S2) mm
ARE8-5050	500	390	40	350	420	250
ARE10-5050	500	490	40	450	420	350
ARE12-5050	500	590	40	550	420	450
ARE14-5050	500	690	40	650	420	550
ARE16-5050	500	790	40	750	420	650
ARE20-5050	500	990	40	950	420	850
ARE24-5050	500	1190	40	1150	420	1050
ARE28-5050	500	1390	40	1350	420	650-600
ARE32-5050	500	1590	40	1550	420	750-700
ARE36-5050	500	1790	40	1750	420	850-800
ARE40-5050	500	1990	40	1950	420	950-900
ARE8-6060	600	390	40	350	520	250
ARE10-6060	600	490	40	450	520	350
ARE12-6060	600	590	40	550	520	450
ARE14-6060	600	690	40	650	520	550
ARE16-6060	600	790	40	750	520	650
ARE20-6060	600	990	40	950	520	850
ARE24-6060	600	1190	40	1150	520	1050
ARE28-6060	600	1390	40	1350	520	650-600
ARE32-6060	600	1590	40	1550	520	750-700
ARE36-6060	600	1790	40	1750	520	850-800
ARE40-6060	600	1990	40	1950	520	950-900