

# MADONNA

INS-VS1

ALL MEASUREMENTS ARE IN MILLIMETRES

MANUFACTURED FROM STAINLESS STEEL

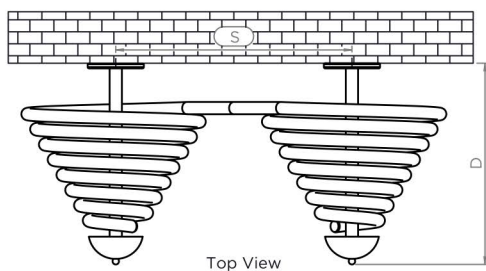
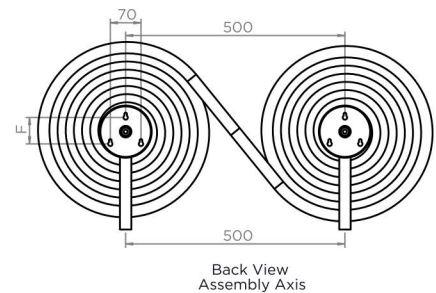
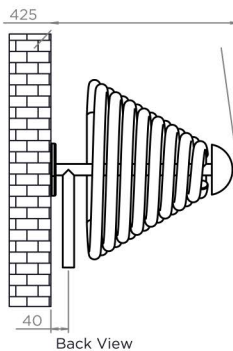
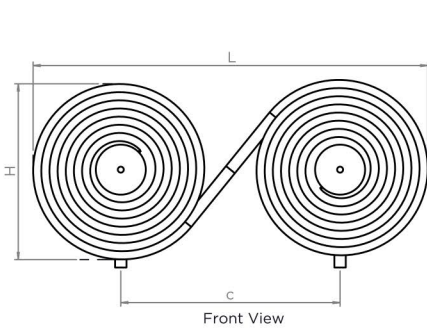
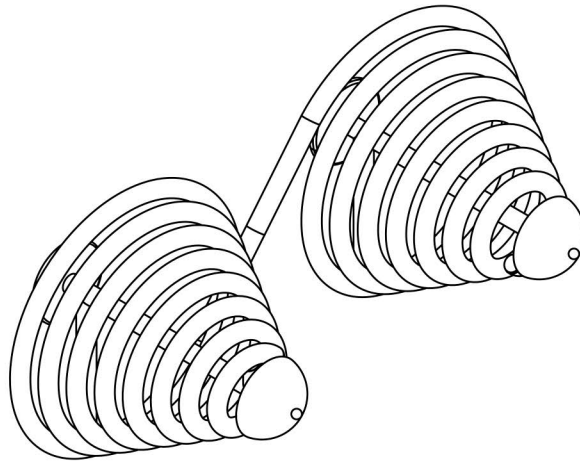

## Installation Accessories:

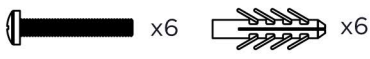

## Plumbing Position:

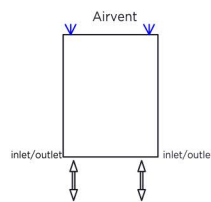

Horizontal mount  
All Dimensions are in mm  
Max. Working Pressure: 10 Bar  
Max. Working Temperature: 95° C  
Inlet / Outlet : 1/2" BSP  
Fuel : H  
Manufacturing Tolerance : - 5 mm

PRODUCT CODE	Height	Length	Depth	Pipe Centres	Bracket Centres	
	H mm	L mm	D mm	C mm	F mm	S mm
MAD400	400	900	425	500	60	500