

PETIT

INS-VS1

ALL MEASUREMENTS ARE IN MILLIMETRES

MANUFACTURED FROM STAINLESS STEEL

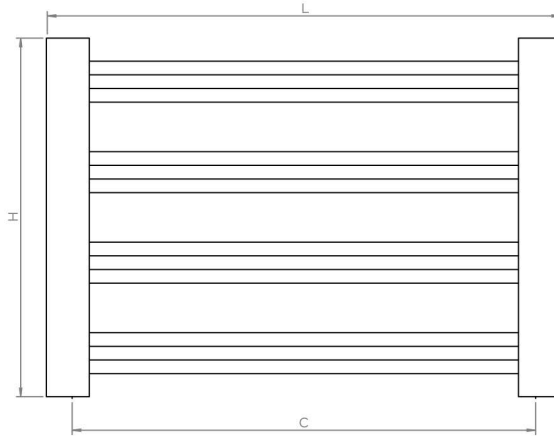
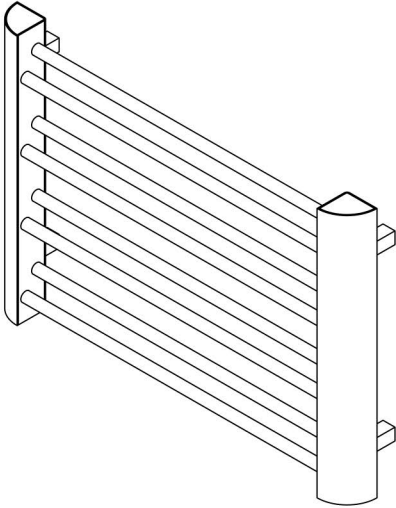

Front View

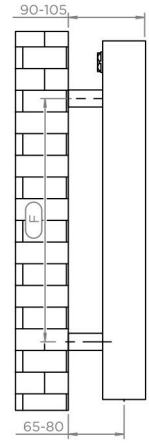

Side View

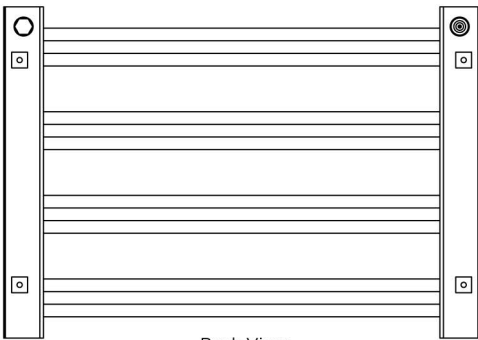

Back View

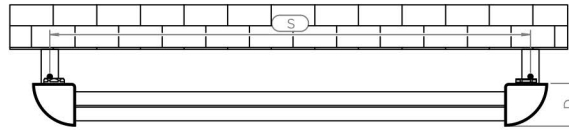

Top View

Installation Accessories:

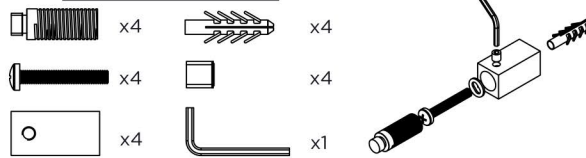

Plumbing Position:

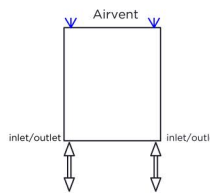

Vertical mount
 All Dimensions are in mm
 Max. Working Pressure: 10 Bar
 Max. Working Temperature: 95° C
 Inlet / Outlet : 1/2" BSP
 Fuel : E/H/D

Manufacturing Tolerance : - 5 mm

PRODUCT CODE	Height	Length	Depth	Pipe Centres	Bracket Centres	
	H	L	D	C	F	S
	mm	mm	mm	mm	mm	mm
PETS46	420	600	50	540	285	560