

# WAVE HORIZONTAL

INS-VS1

ALL MEASUREMENTS ARE IN MILLIMETRES

MANUFACTURED FROM STAINLESS STEEL

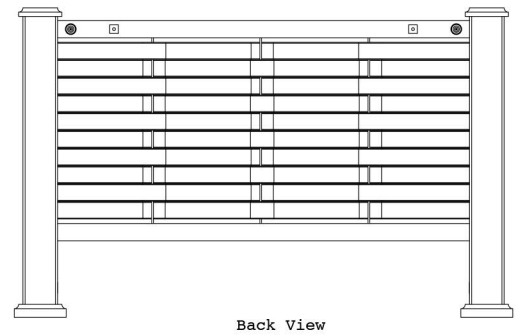
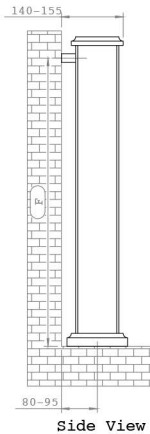
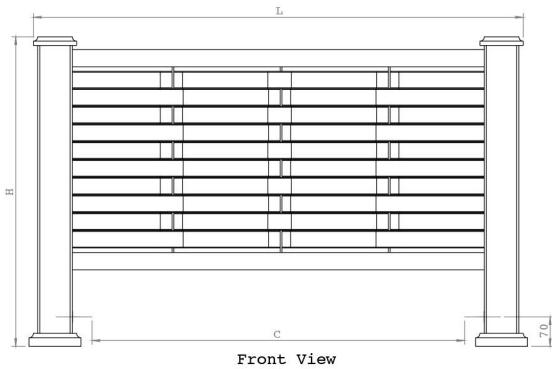
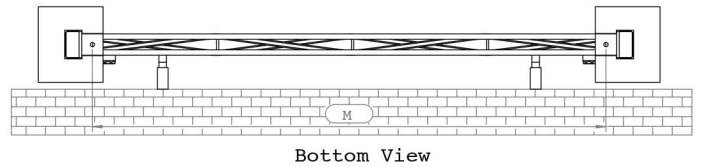
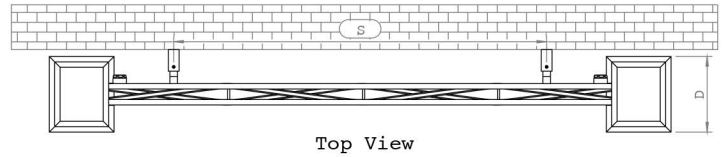
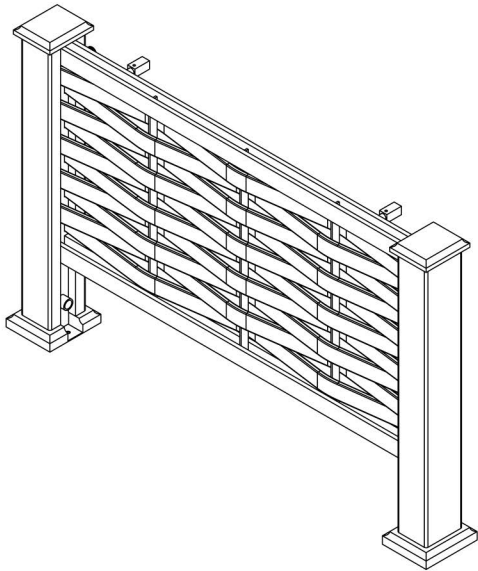

## Plumbing Position



## Installation Accessories:

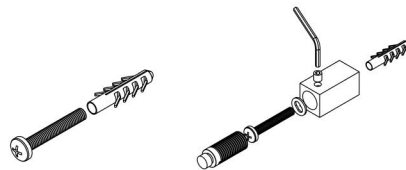
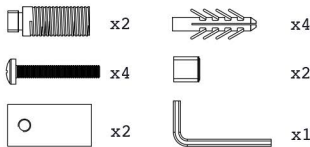

PRODUCT CODE	Height	Length	Depth	Pipe Centres	Bracket Centres		
	H mm	L mm	D mm	C mm	F mm	S mm	M mm
WA710h	715	1150	100	860	665	690	950
WA715h	715	1650	100	1360	665	1190	1450
WA720h	715	2150	100	1860	665	1690	1950
Stainless Steel (WSSS)*	S.Steel	Pillars	Pair	-	-	-	-
Nero Assuloto (WSNA)*	Granite	Pillars	Pair	-	-	-	-
Travertine Classico (WSTC)*	Travertine	Pillars	Pair	-	-	-	-
Crema Marfil (WSCM)*	Marble	Pillars	Pair	-	-	-	-
Verde Butterfly (WSVB)*	Granite	Pillars	Pair	-	-	-	-
Labrador Antique (WSLA)*	Granite	Pillars	Pair	-	-	-	-

Vertical mount  
 All Dimensions are in m  
 Max.Working Pressure: 5  
 Max.Working Temperature  
 Inlet / Outlet : 1/2" B  
 Fuel : H  
 Manufacturing Tolerance : - 5 mm