

08.

V815TKM

A	B	C	E	F	D
60.5	40	30	24x19 - 3/4"EK	31.5	35

V861TKM

A	B	C	E	F	D
39	40	30	24x19 - 3/4"EK	31.5	35

V865TKM

A	B	C	E	F	D
38	40	30	24x19 - 3/4"EK	31.5	35

V871TKM

A	B	C	E	F	D
51.5	40	30	24x19 - 3/4"EK	31.5	35

V875TKM

A	B	C	E	F	D
51.5	40	30	24x19 - 3/4"EK	31.5	35

V057

D	A	B	C
1/2"	63	40	30
1/2"	63	50	30

A551

A	B	C
3/8"	13.5	24
1/2"	13.5	24

V056

A
1/4"
3/8"
1/2"

V055

A	B
1/4"	19
3/8"	19
1/2"	25

A351

A560

A561

A409

A499

A497

A403

V058

08.

V1521

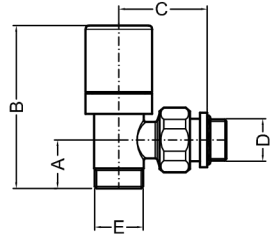

D	A	B	C	E
3/8"	24	80	44	24x19-3/4EK
1/2"	24	80	44	24x19-3/4EK

V1523

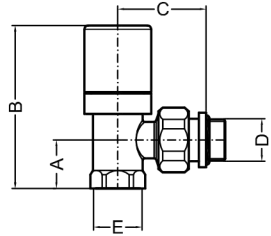

D	A	B	C	E
3/8"	24	80	44	3/8"F
1/2"	24	80	44	1/2"F

V1525

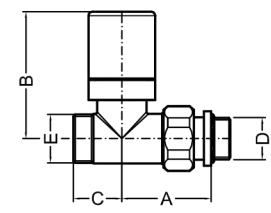

D	A	B	C	E
3/8"	44	63	24	24x19-3/4EK
1/2"	44	63	24	24x19-3/4EK

V1527

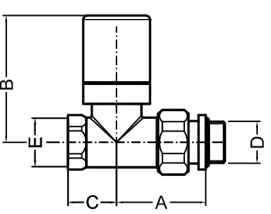

D	A	B	C	E
3/8"	44	63	24	3/8"F
1/2"	44	63	24	1/2"F

V1511

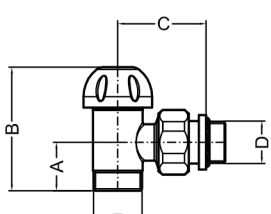

D	A	B	C	E
3/8"	24	61	44	24x19-3/4EK
1/2"	24	61	44	24x19-3/4EK

V1513

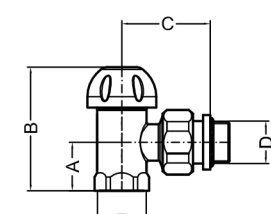

D	A	B	C	E
3/8"	24	61	44	3/8"F
1/2"	24	61	44	1/2"F

V1515

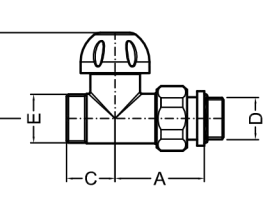

D	A	B	C	E
3/8"	44	43	24	24x19-3/4EK
1/2"	44	43	24	24x19-3/4EK

V1517

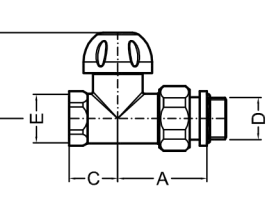

D	A	B	C	E
3/8"	44	43	24	3/8"F
1/2"	44	43	24	1/2"F

V1501

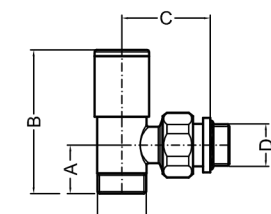

D	A	B	C	E
3/8"	24	70	45	24x19-3/4EK
1/2"	24	70	45	24x19-3/4EK

V1503

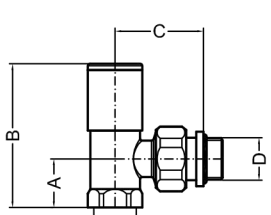

D	A	B	C	E
3/8"	24	70	44	3/8"F
1/2"	24	70	44	1/2"F

V1505

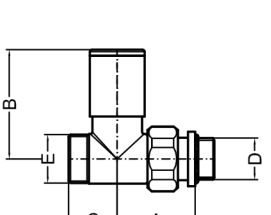

D	A	B	C	E
3/8"	38.5	54	24	24x19-3/4EK
1/2"	38.5	54	24	24x19-3/4EK

V1507

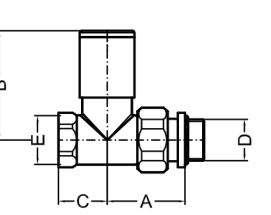

D	A	B	C	E
3/8"	38.5	54	24	3/8"F
1/2"	38.5	54	24	1/2"F

V1502

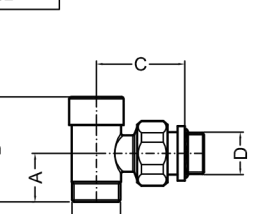

D	A	B	C	E
3/8"	24	52	44	24x19-3/4EK
1/2"	24	52	44	24x19-3/4EK

V1504

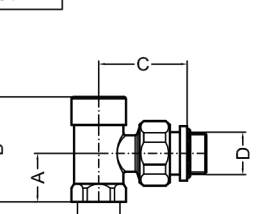

D	A	B	C	E
3/8"	24	52	44	3/8"F
1/2"	24	52	44	1/2"F