

08.

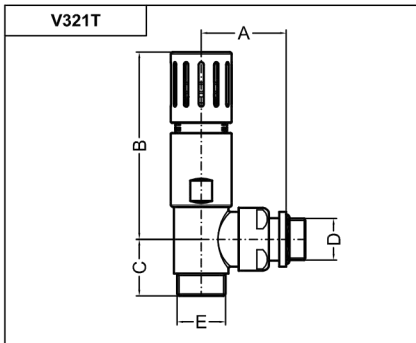

D	A	B	C	E
3/8"	42	96	26	24x19-3/4EK
1/2"	42	96	26	24x19-3/4EK

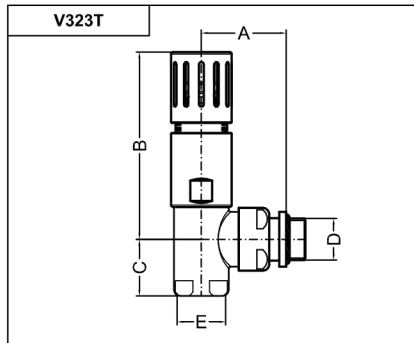

D	A	B	C	E
3/8"	42	96	26	3/8"F
1/2"	42	96	26	1/2"F

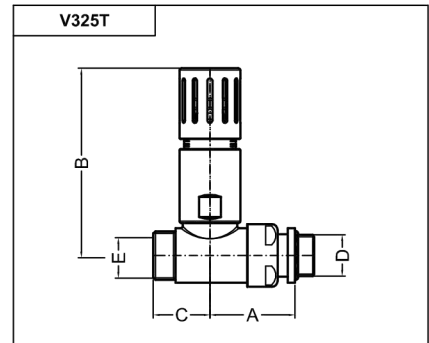

D	A	B	C	E
3/8"	42	95	26	24x19-3/4EK
1/2"	42	96	26	24x19-3/4EK

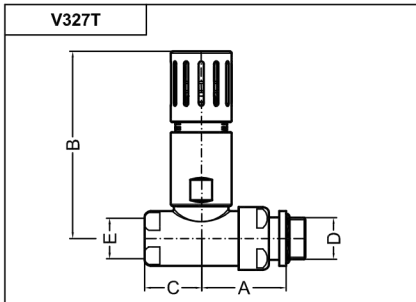

D	A	B	C	E
3/8"	42	96	26	3/8"F
1/2"	42	96	26	1/2"F

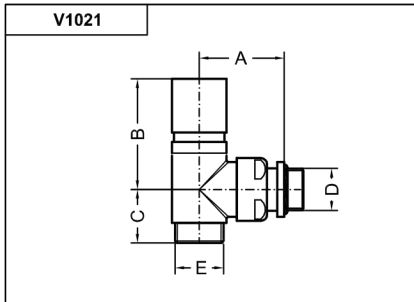

D	A	B	C	E
3/8"	42	55	26	24x19-3/4EK
1/2"	42	55	26	24x19-3/4EK

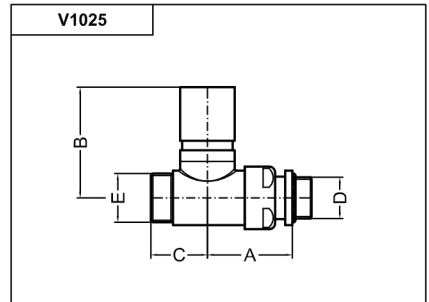

D	A	B	C	E
3/8"	42	55	26	24x19-3/4EK
1/2"	42	55	26	24x19-3/4EK

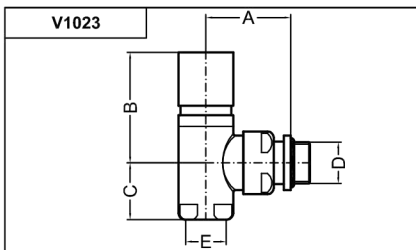

D	A	B	C	E
3/8"	42	55	26	3/8"F
1/2"	42	55	26	1/2"F

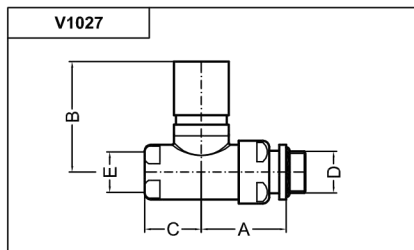

D	A	B	C	E
3/8"	42	55	26	3/8"F
1/2"	42	55	26	1/2"F

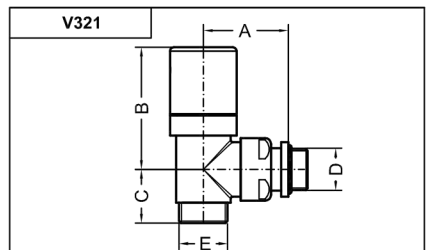

D	A	B	C	E
3/8"	42	61	26	24x19-3/4EK
1/2"	42	61	26	24x19-3/4EK

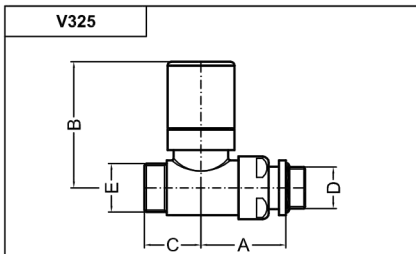

D	A	B	C	E
3/8"	42	63	26	24x19-3/4EK
1/2"	42	63	26	24x19-3/4EK

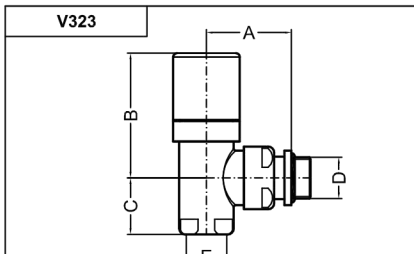

D	A	B	C	E
3/8"	42	62	26	3/8"F
1/2"	42	62	26	1/2"F

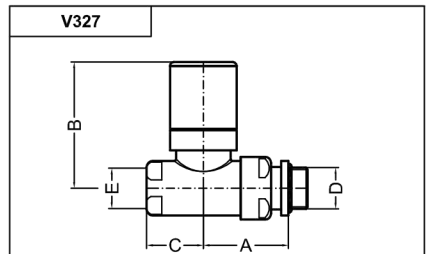

D	A	B	C	E
3/8"	42	63	26	3/8"F
1/2"	42	63	26	1/2"F

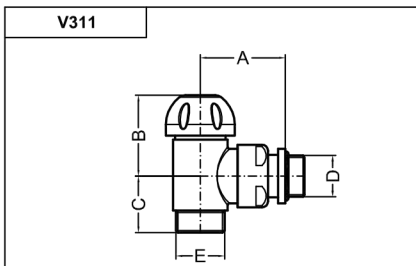

D	A	B	C	E
3/8"	42	40	26	24x19-3/4EK
1/2"	42	40	26	24x19-3/4EK

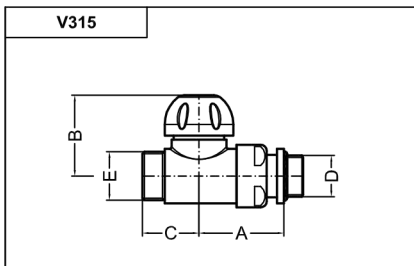

D	A	B	C	E
3/8"	42	40	26	24x19-3/4EK
1/2"	42	40	26	24x19-3/4EK

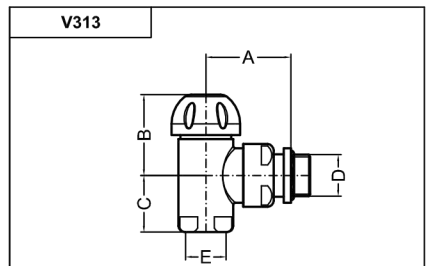

D	A	B	C	E
3/8"	42	40	26	3/8"F
1/2"	42	40	26	1/2"F

08.

V815TKM

A	B	C	E	F	D
60.5	40	30	24x19 - 3/4"EK	31.5	35

V861TKM

A	B	C	E	F	D
39	40	30	24x19 - 3/4"EK	31.5	35

V865TKM

A	B	C	E	F	D
38	40	30	24x19 - 3/4"EK	31.5	35

V871TKM

A	B	C	E	F	D
51.5	40	30	24x19 - 3/4"EK	31.5	35

V875TKM

A	B	C	E	F	D
51.5	40	30	24x19 - 3/4"EK	31.5	35

V057

D	A	B	C
1/2"	63	40	30
1/2"	63	50	30

A551

A	B	C
3/8"	13.5	24
1/2"	13.5	24

A351

A560

A561

V056

A
1/4"
3/8"
1/2"

V055

A	B
1/4"	19
3/8"	19
1/2"	25

A409

A499

A497

A403

V058